

**MUND UND ZUNGE**

**MOUTH AND TONGUE**

**BOUCHE ET LANGUE**

**BOCA Y LENGUA**

**BOCCA E LINGUA**

In packungen zu 100 Stück  
 In Packet of 100 ea.  
 En boîtes de 100 pièces  
 En cajas de 100 c/u  
 In scatole di 100 pezzi

Zungenspatel  
 Tongue Depressors  
 Abaisse-langue  
 Abajalengua  
 Abbassalingua

MUND UND ZUNGE

MOUTH AND TONGUE

BOUCHE ET LANGUE

BOCA Y LENGUA

BOCCA E LINGUA



cm  
 16,0 48-1002-16



cm FRENZEL  
 16,5 48-1005-16



cm BRUENINGS  
 19,0 48-1007-19



cm  
 14,0 48-1008-14



cm BUCHWALD  
 19,0 48-1009-19

Holz  
 wood  
 bois  
 madera  
 legno



cm Fig. 1  
 14,0 48-1105-01



cm Fig. 2  
 15,0 48-1105-02



cm DOYEN  
 13,0 48-1011-13  
 16,0 48-1011-16

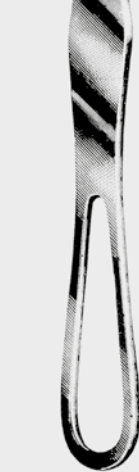

cm HARTMANN  
 15,0 48-1101-15



WIEDER  
 48-1105-01 - 48-1105-02



cm ANDREW  
 11,0 48-1107-11

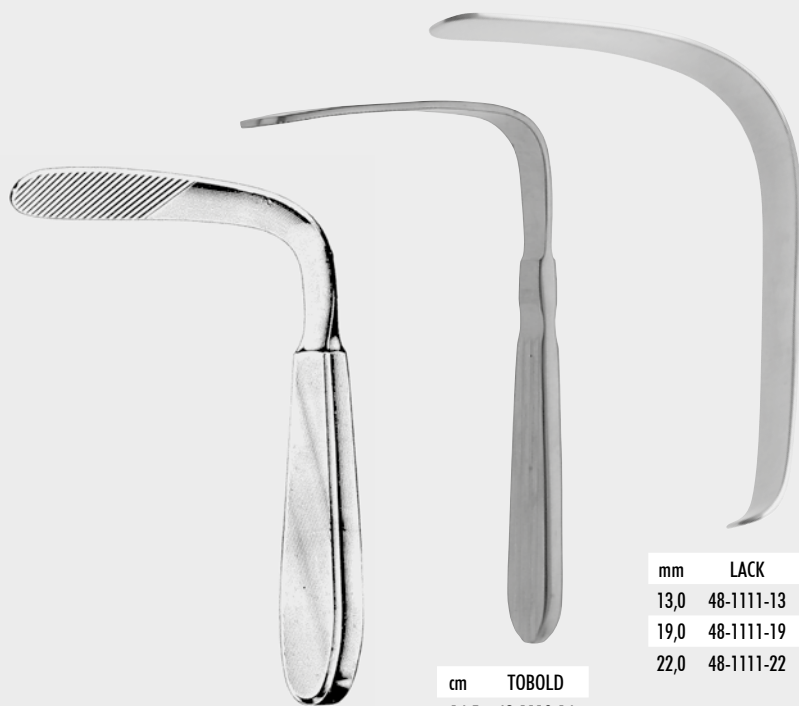

cm TOBOLD  
14,5 48-1109-14

cm TOBOLD  
14,5 48-1110-14

mm	LACK
13,0	48-1111-13
19,0	48-1111-19
22,0	48-1111-22

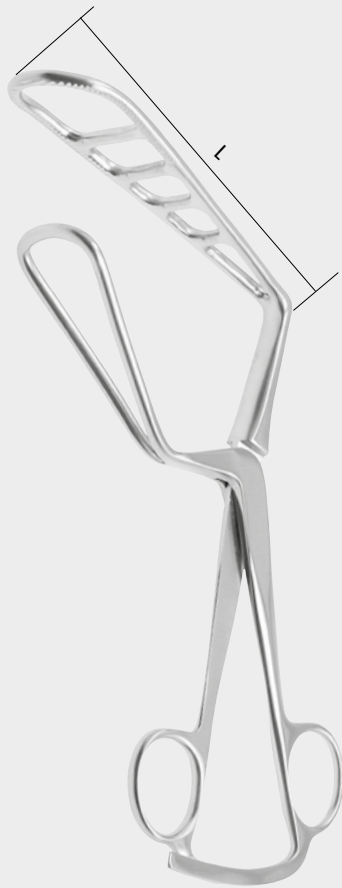

L=cm	STIERLEN
7,0	48-1115-07
9,0	48-1115-09
10,0	48-1115-10

Zungendrucker, Lippenhalter  
Tongue Depressors, Lip Retractors  
Abaisse-langue, Écarteurs des lèvres  
Abajalengua, Separadores de labios  
Abbassalingua, Divaricatori di labbra

MUND UND ZUNGE

MOUTH AND TONGUE

BOUCHE ET LANGUE

BOCA Y LENGUA

BOCCA E LINGUA



cm MORTIZ-SCHMIDT  
19,0 48-1113-19

cm LE MEE  
20,0 48-1119-14

cm	STERNBERG
14,0	48-2207-14
16,0	48-2207-16
18,0	48-2207-18

cm	STERNBERG
12,0	48-2209-12
14,0	48-2209-14
16,0	48-2209-16

cm	
8,0	48-2211-08
9,0	48-2211-09
	21,0 cm

Wangen-, Lippenhalter  
 Cheek, Lip Retractors  
 Écarteurs des joues et des lèvres  
 Separadores de mejillas y de labios  
 Divaricatori di guance e di labbra

## MUND UND ZUNGE

## MOUTH AND TONGUE

## BOUCHE ET LANGUE

## BOCA Y LENGUA

## BOCCA E LINGUA

Zungenzangen  
 Tongue Holding Forceps  
 Pincers tire-langue  
 Pinzas tiralingua  
 Pinze tiralingua



cm  
11,0 48-2300-11



cm CAWOOD-MINNESOTA  
15,0 48-2303-15

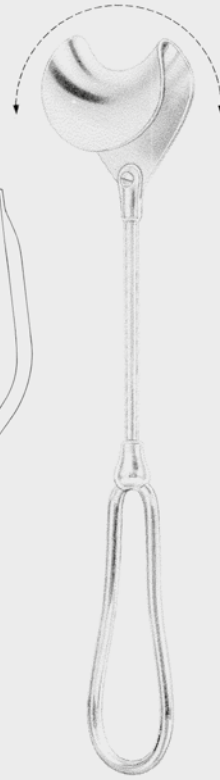

cm  
19,0 48-2305-19



cm LASTER  
10,0 48-2307-10



cm HAJEK  
16,5 48-2309-16



cm COLLIN  
16,0 48-2500-16  
18,0 48-2500-18



cm YOUNG  
16,0 48-2505-16

48-2505-99

Mundsperrer  
 Mouth Gags  
 Ouvre-bouche  
 Abrebocas  
 Apribocca



cm DOYEN-JANSEN (MOLT)  
 12,0 48-2605-12

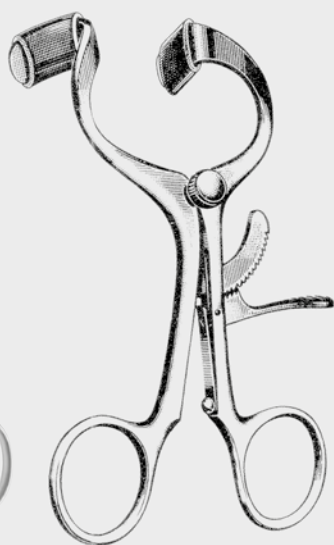

cm DOYEN-JANSEN (MOLT)  
 14,0 48-2605-14



cm DENHART  
 12,0 48-2606-12

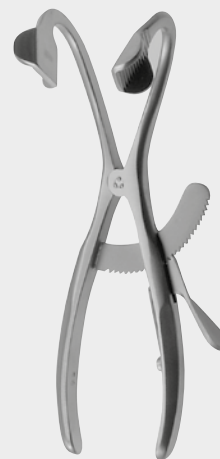

cm DENHART  
 12,0 48-2607-12

MUND UND ZUNGE

MOUTH AND TONGUE

BOUCHE ET LANGUE

BOCA Y LENGUA

BOCCA E LINGUA

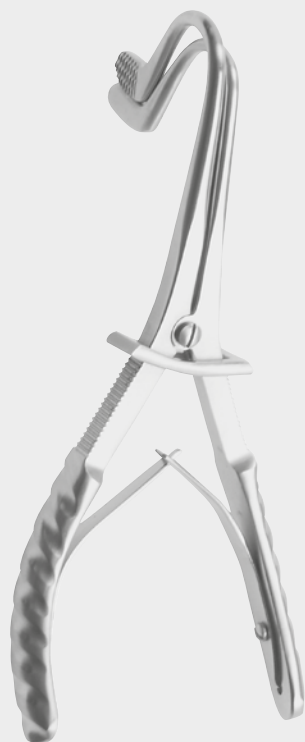

cm FERGISSON-ACKLAND  
 15,5 48-2609-15  
 21,0 48-2609-21

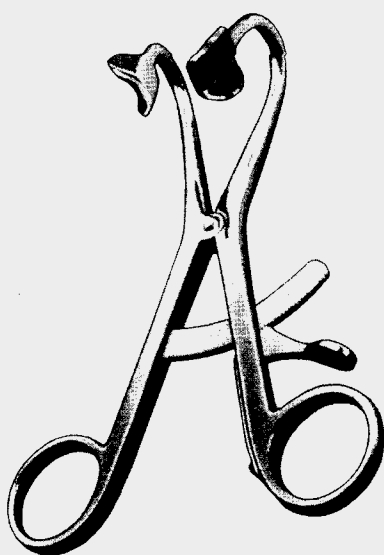

cm FEATHERSTONE  
 16,0 48-2615-16

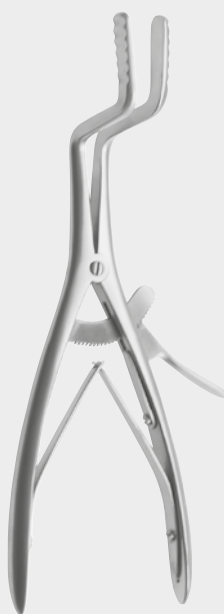

cm ROSER-KOENIG  
 16,0 48-2700-16  
 19,0 48-2700-19

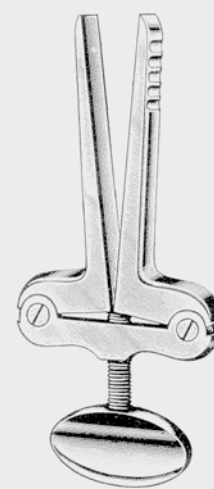

cm HEISTER  
 13,0 48-2702-13

Mundsperrer  
 Mouth Gags  
 Ouvre-bouche  
 Abrebocas  
 Apribocca

MUND UND ZUNGE

MOUTH AND TONGUE

BOUCHE ET LANGUE

BOCA Y LENGUA

BOCCA E LINGUA

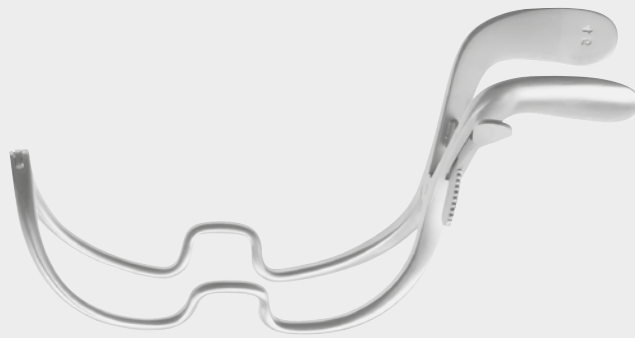

cm	JENNINGS
9,0	48-2704-09
11,0	48-2704-11
13,0	48-2704-13
15,0	48-2704-15

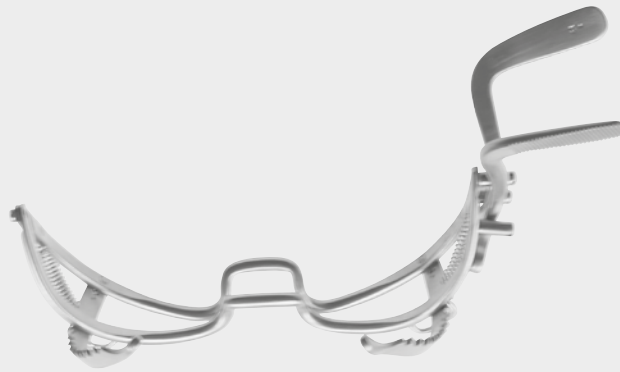

cm	WHITEHEAD
11,0	48-2800-11
13,0	48-2800-13
15,0	48-2800-15

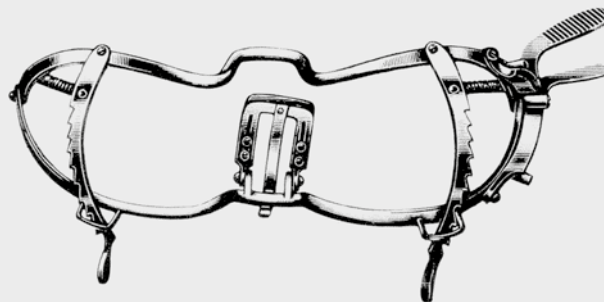

cm	WHITEHEAD
11,0	48-2801-11
13,0	48-2801-13
15,0	48-2801-15

mit Zungendrucker  
 with tongue depressor  
 avec abaisse-langue  
 con abajalengua  
 con abbassalingua



48-3100-99  
Gummieinlage  
Rubber Lining  
Caoutchouc seul  
Goma suelta  
Gomma sola

Rahmen allein  
Frame only  
Cadre seul  
Cuadro suelto  
Telaio solo

48-3100-10  
48-3100-12

f. Jugendliche - for adolescents  
p. adolescents - p. adolescentes - p. adolescenti

DAVIS-BOYLE compl.

48-3100-00

incl. 48-3100-10, 48-3100-01, -02, -03, -04, -05



48-3100-05  
26 x 108 mm Fig. 5

48-3100-04  
25 x 93 mm Fig. 4

48-3100-03  
24 x 80 mm Fig. 3

48-3100-02  
23 x 65 mm Fig. 2



48-3100-01  
21 x 30 mm Fig. 1

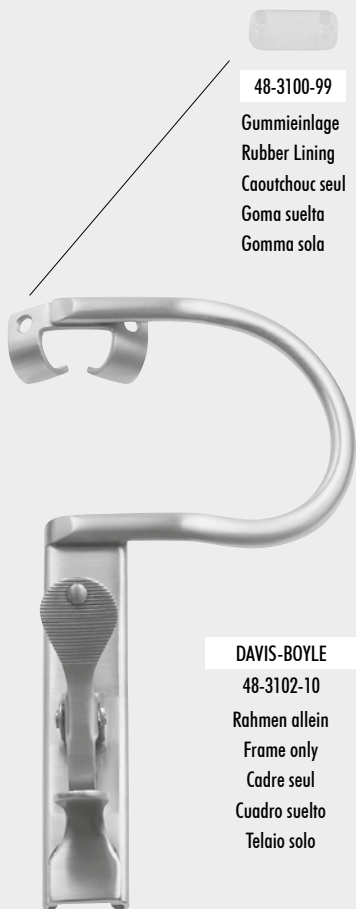

48-3100-99  
Gummieinlage  
Rubber Lining  
Caoutchouc seul  
Goma suelta  
Gomma sola

DAVIS-BOYLE  
48-3102-10  
Rahmen allein  
Frame only  
Cadre seul  
Cuadro suelto  
Telaio solo

DAVIS-BOYLE compl.

48-3102-00

incl. 48-3102-10, 48-3102-01, -02, -03, -04, -05



48-3102-05  
22 x 80 mm Fig. 5



48-3102-04  
22 x 71 mm Fig. 4



48-3102-03  
20 x 58 mm Fig. 3



48-3102-02  
19 x 46 mm Fig. 2



48-3102-01  
17 x 26 mm Fig. 1

Mundsperrer für Erwachsene  
Mouth Gags Adult Size  
Ouvre-bouche pour adultes  
Abrebocas para adultos  
Apribocca per adulti

MUND UND ZUNGE

MOUTH AND TONGUE

BOUCHE ET LANGUE

BOCA Y LENGUA

BOCCA E LINGUA

Mundsperrer für Kinder  
Mouth Gags Child Size  
Ouvre-bouche pour enfants  
Abrebocas para niños  
Apribocca per bambini

Mundsperrer  
 Mouth Gags  
 Ouvre-bouche  
 Abrebocas  
 Apribocca

MUND UND ZUNGE

MOUTH AND TONGUE

BOUCHE ET LANGUE

BOCA Y LENGUA

BOCCA E LINGUA



48-3105-10

Rahmen allein  
 Frame only  
 Cadre seul  
 Cuadro suelto  
 Telaio solo

KILNER-DOUGHTY compl.

48-3105-00

incl. 48-3105-10, 48-3105-01, -02, -03, 48-3105-99

48-3105-01  
 28 x 65 mm Fig. 1



48-3105-02  
 32 x 75 mm Fig. 2

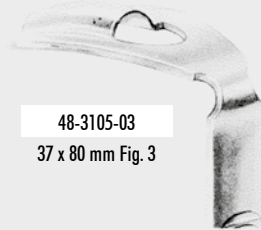

48-3105-03  
 37 x 80 mm Fig. 3



48-3105-99



48-3200-10

Rahmen allein  
 Frame only  
 Cadre seul  
 Cuadro suelto  
 Telaio solo

McVOR compl.

48-3200-00

incl. 48-3200-10, 48-3200-01, -02, -03

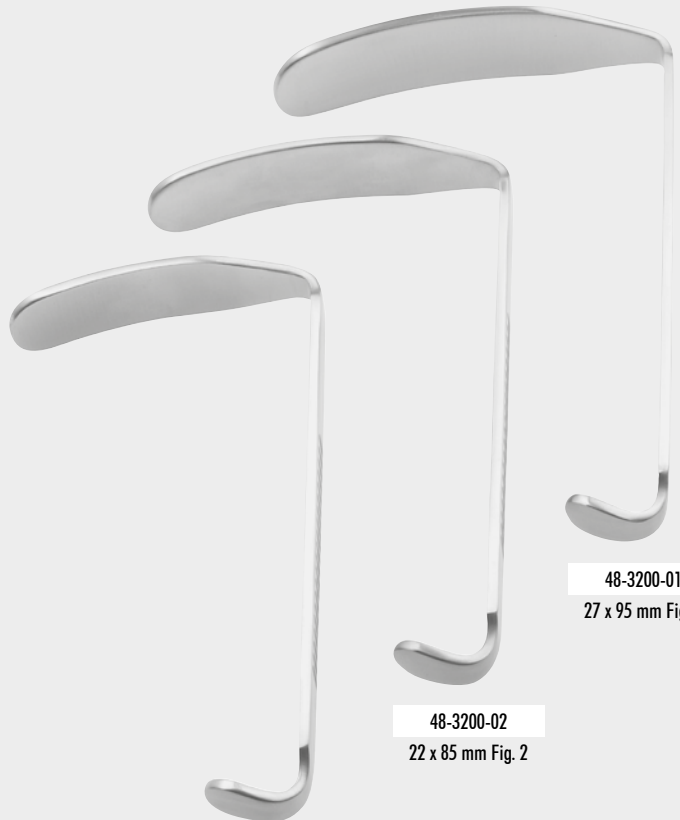

48-3200-01  
 27 x 95 mm Fig. 1

48-3200-02  
 22 x 85 mm Fig. 2

48-3200-03  
 22 x 70 mm Fig. 3

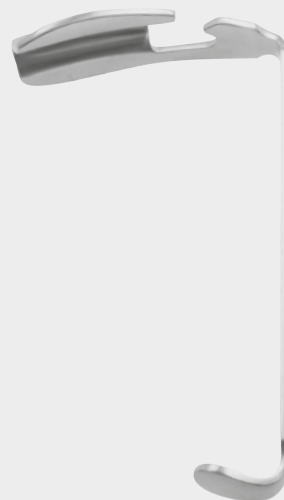
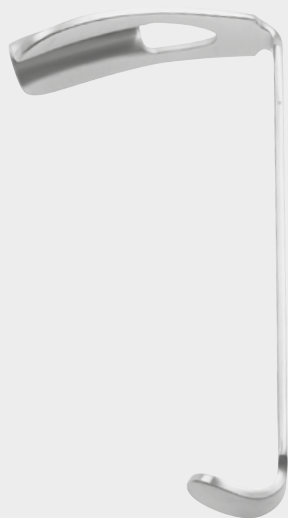

Mundsperrer  
Mouth Gags  
Ouvre-bouche  
Abrebocas  
Apribocca

Fig.	mm	RUSSEL-DAVIS
1	28 x 65	48-3202-01
2	32 x 75	48-3202-02
3	37 x 80	48-3202-03
4	40 x 90	48-3202-04
5	45 x 100	48-3202-05

Fig.	mm	RUSSEL-DAVIS
1	18 x 55	48-3204-01
2	22 x 65	48-3204-02
3	25 x 75	48-3204-03

extra schmal - extra narrow - très étroits  
extra estrechos - extrastretti

Fig.	mm	GAST
1	28 x 64	48-3206-01
2	34 x 74	48-3206-02
3	38 x 87	48-3206-03

MUND UND ZUNGE

MOUTH AND TONGUE

BOUCHE ET LANGUE

BOCA Y LENGUA

BOCCA E LINGUA



48-3208-10

Rahmen allein  
Frame only  
Cadre seul  
Cuadro suelto  
Telaio solo

DAVIS-MEYER compl.  
48-3208-00  
incl. 48-3208-10, 48-3208-01, -02, -03, -04, -05, -06, -07



Fig.	mm	DAVIS-MEYER
1	29,0 x 70	48-3208-01
2	30,5 x 75	48-3208-02
3	31,5 x 80	48-3208-03
4	32,5 x 85	48-3208-04
5	33,5 x 95	48-3208-05
6	33,8 x 100	48-3208-06
7	34,0 x 105	48-3208-07



Mundsperrer  
 Mouth Gags  
 Ouvre-bouche  
 Abrebocas  
 Apribocca

## MUND UND ZUNGE

## MOUTH AND TONGUE

## BOUCHE ET LANGUE

## BOCA Y LENGUA

## BOCCA E LINGUA

Zungendrucker für Mundsperrer  
 Tongue Depressors for Mouth Gags  
 Abaisse-langue pour ouvre-bouche  
 Abajalengua para abrebocas  
 Abbassalingua per apribocca

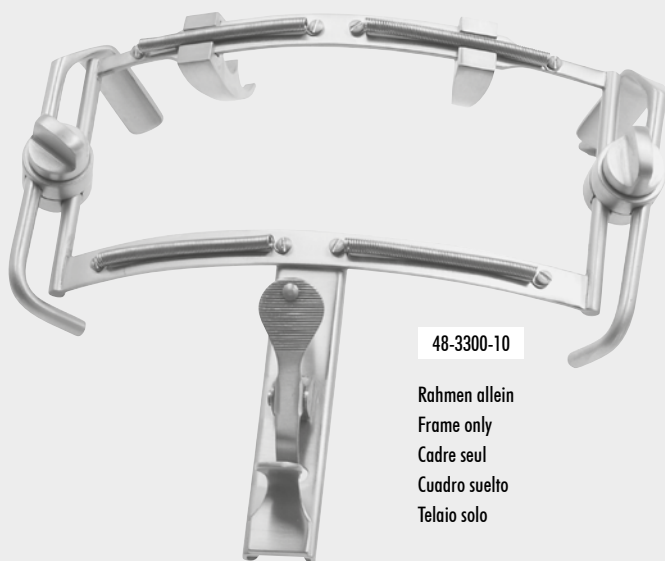

48-3300-10

Rahmen allein  
 Frame only  
 Cadre seul  
 Cuadro suelto  
 Telaio solo

DINGMANN compl.

48-3300-00

incl. 48-3300-10, 48-3300-01, -02, -03

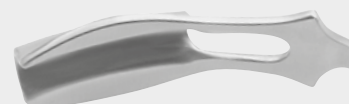

48-3300-03

31 x 75 mm Fig. 3

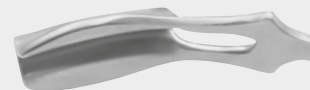

48-3300-02

28 x 65 mm Fig. 2

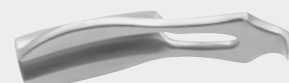

48-3300-01

24 x 63 mm Fig. 1

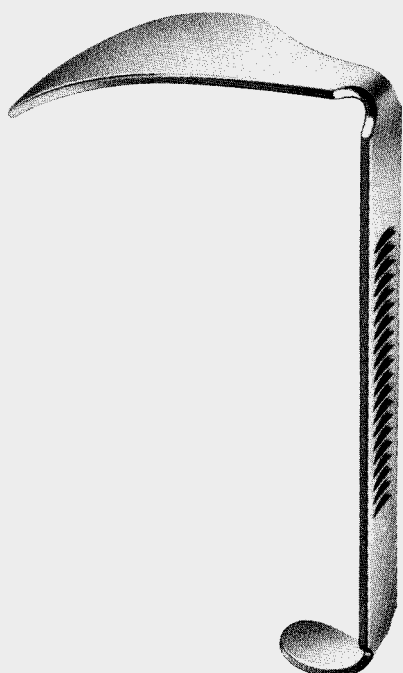

Fig.	mm	HERBERHOLD
1	28 x 63	48-3310-01
2	33 x 73	48-3310-02
3	37 x 82	48-3310-03
4	42 x 90	48-3310-04

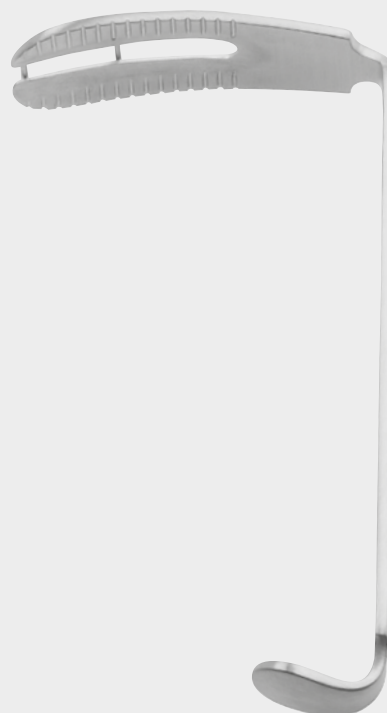
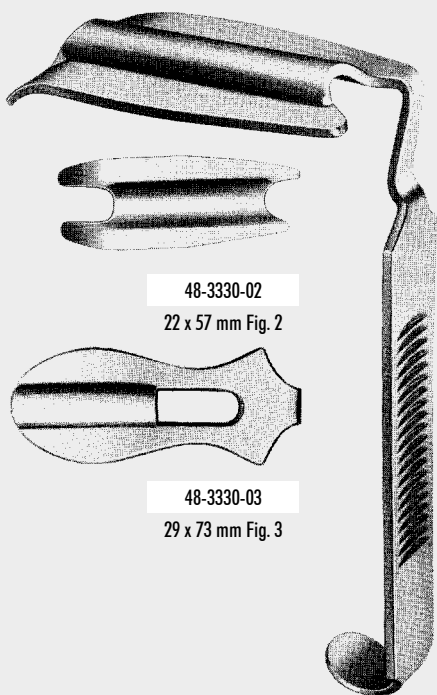

Fig.	mm	WÜRZBURG
1	28 x 66	48-3320-01
2	32 x 75	48-3320-02
3	34 x 83	48-3320-03
4	37 x 93	48-3320-04
5	38 x 100	48-3320-05



48-3330-02  
22 x 57 mm Fig. 2

48-3330-03  
29 x 73 mm Fig. 3

48-3330-04  
32 x 89 mm Fig. 4

48-3330-05  
38 x 95 mm Fig. 5

RING  
» 48-3330-02 - 48-3330-05  
« 48-3331-02 - 48-3331-05

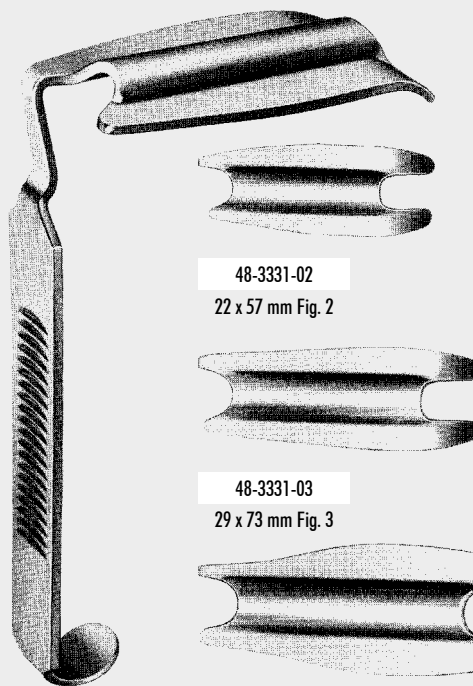

48-3331-02  
22 x 57 mm Fig. 2

48-3331-03  
29 x 73 mm Fig. 3

48-3331-04  
32 x 89 mm Fig. 4

48-3331-05  
38 x 95 mm Fig. 5

Zungendrucker für Mundsperrer  
Tongue Depressors for Mouth Gags  
Abaisse-langue pour ouvre-bouche  
Abajalengua para abre bocas  
Abbassalingua per apribocca

MUND UND ZUNGE

MOUTH AND TONGUE

BOUCHE ET LANGUE

BOCA Y LENGUA

BOCCA E LINGUA



NEGUS  
48-3340-00 für Erwachsene - for adults - pour adultes - para adultos - per adulti  
48-3341-00 für Kinder - for children - pour enfants - para niños - per bambini

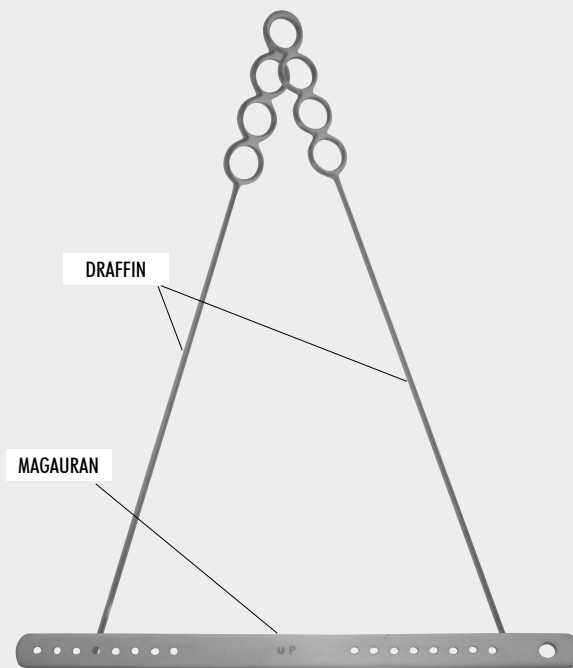

DRAFFIN compl.  
48-3345-00

Bruststütze, Bipod  
Chest Support, Bipod  
Support de poitrine, Bipod  
Soporte de pecho, Bipod  
Supporto di petto, Bipod

Mundkeil, Fingerschützer  
 Oral Screw, Finger Protectors  
 Baillon, Doigtiers  
 Garrote, Dedales  
 Apribocca, Ditali



**MAUNDER**  
48-3600-10

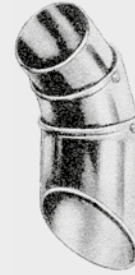

Fig. MC KESSON  
 1 48-3610-01  
 2 48-3610-02  
 3 48-3610-03  
 4 48-3610-04  
 5 48-3610-05



48-3701-01

Fig. 1



**LANGENBECK**  
48-3701-02

Fig. 2

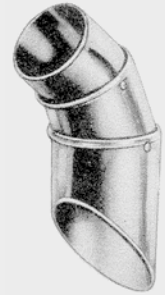

48-3701-03

Fig. 3

## MUND UND ZUNGE

## MOUTH AND TONGUE

## BOUCHE ET LANGUE

## BOCA Y LENGUA

## BOCCA E LINGUA

Repositions-Zangen  
 Reposition Forceps  
 Pincers à redresser  
 Pinzas de enderezamiento  
 Pinze per radrizzare



**ROWE**  
48-5002-00

Verbindungsstück für 2 Zangen  
 Connector for 2 forceps  
 Connecteur pour 2 pinces  
 Conector para 2 pinzas  
 Connettore per 2 pinze



cm	« ROWE		ROWE »
22,0	48-5001-22	Säugling - baby - bébé - bebe	48-5003-22
23,0	48-5001-23	Kinder- child - enfant - niños - bambino	48-5003-23
24,0	48-5001-24	Erwachsene - adult - adulte - adulto	48-5003-24